

Physical Specification

Nominal Voltage		12V
Nominal Capacity (10Hr)		3.0 Ah
Dimension	Length	112±2mm (4.45 inches)
	Width	69±2mm (2.76 inches)
	Container Height	85±2mm (3.35 inches) Total
	Height (with Terminal)	85±2mm(3.35 inches)
Weight	Approx0.55kg(1.21lbs)	

- * Motorcycle Li-ion battery
- * Maintenance-free
- * Real-time protection (overcharge, over-discharge, over-temperature) and energy balance of battery system through BMS
- * Powerful 105 cold cranking amps
- * Shipped pre-charged and ready to install
- * Replaces YTX4L-BS、YTZ5S-BS、YTX5L-BS、YTZ6-BS、YTX7L-BS battery



Electrical Specification

Rated Capacity	0.1C rate (0.30A)	3.00Ah
	0.5C rate (1.50A)	3.00Ah
	10Crate (30.0A)	2.70Ah
	60Crate(180.0A)	3S
Capacity affected by Temperature	40 °C (104 °F)	98%
	25 °C (77 °F)	100%
	0 °C (32 °F)	85%
	-20 °C (-4 °F)	60%
Self Discharge	Approximately 1.5% per month (25°C (77° F))	
Charging Methods	Constant-Voltage Charge:	
	Full Charge Initial charging current: less than 3.5A Voltage: 14.40 V ~ 14.60 V at 25 °C (77 °F)	

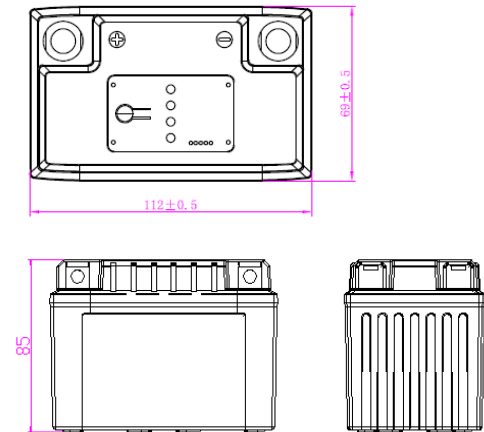

Dimensions (mm)

Curve Specification

